



Make A Connection To Life[®]

Floating Docks
PWC Docking
Kayak Launch

Featured Dock Items



Connect-A-Port XL5

59" x 156" x 23" (149.9 cm x 396.24 cm x 58.42 cm)

Weight: 320 lbs (145.15 kg)

Maximum Flotation: 1800 lbs (816.5 kg)

Model: CAPXL5



YAKport®

48" x 60" x 22" outside

(121.9 cm x 152.4 cm x 55.88 cm)

34" x 17" inside

(86.36 cm x 43.18 cm)

KL1020

Create a safe/stable cradle for your Kayak
Attach to Floating or Fixed Docks



Float Section FS1120 1000 Series - Low Profile

90" x 120" x 10" (228.6 cm x 304.8 cm x 25.4 cm)

Maximum flotation: 2800 lbs (1270 kg) per module

Freeboard: 8" (20.32 cm) above the water



Featured Dock Items

1000 Series & 2000 Series ii
Kayak launch
YAKport.....2
PWC Docking
Connect-A-Port4

1000 Series - Low Profile (LP)

Specifications & Information6
Components.....8
Packages16

2000 Series - High Profile (HP)

Specifications & Information18
Components..... 20
Packages 30

1000 Series - (LP) & 2000 Series - (HP)

Anchoring 32
Technical Specifications 34
Installation, Warranties & Patents 36

Dock Applications

1000 Series & 2000 Series37



Make a Connection to Life®

To determine which Connect-A-Dock Series is best for you, consider the following:

How am I going to use my dock?

What is the size of the body of water in which my dock will be installed?

1000 Series (LP) has an 8" (20.32 cm) freeboard which is perfect for smaller watercraft.

2000 Series (HP) has a 17" (43.18 cm) freeboard and is designed for larger watercraft.

Find a Connect-A-Dock® dealer online to help determine the best series for you.

Easy on and off the water



YAKport launch makes getting in and out of the water easy for beginners or experienced users. Kayaks, canoes or stand up paddle boards with a width 34" and under can use the YAKport.

Connect to your floating or fixed dock with a selection of accessories and anchoring options. The YAKport Kayak Launch comes in five colors to match your preferences and dock.

Benefits

- Personal Launch Provides a Safe & Stable Cradle for Boarding
- Accommodates Most Kayak & Paddle Board Sizes
- Attaches to Any Dock Floating or Fixed Structure
- Available In 5 Colors – Tan, Light Grey, Dark Grey, Blue & Black
- Optional Entry Handles
- Optional Overhead Handle
- Ultraviolet Protected
- Environmentally Friendly
- Salt Water Safe



YAKport®

48" x 60" x 22" outside (121.9 cm x 152.4 cm x 55.88 cm)
34" x 17" inside (86.36 cm x 43.18cm)

Model: KL1020

Create a safe/stable cradle for your Kayak
Attaches to floating or fixed docks

YAKport Colors



Tan

Light Gray

Blue

Dark Gray

Black



Accessories



Roto Grab Bars & Roto Overhead Assist (sold separately)

YAKGHR1020 - Grab Bar (Matching set)

YAK1022 - Overhead Assist

The Roto Grab Bars are available in five colors and can be used with or without the Roto Grab Bar Overhead Assist.

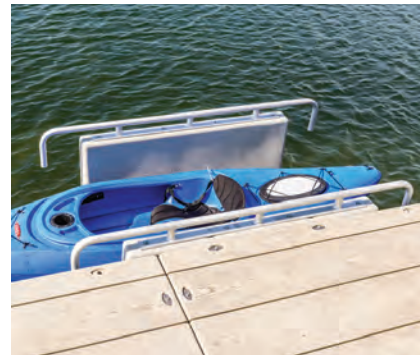

YAK Bars

YAKGHL1020

Enter or exit from either end of the kayak launch.

*Yak Bars are sold individually and can not be used with an overhead bar.

Anchoring



Floating Dock Kit

YAKH1000 (Low Profile)

YAKH2000 (High Profile) *Kit shown

When connecting to a floating dock with metal or wooden framing, use the Floating Dock Kit.

Low - water line to top of Hinge ~ 18"

High - water line to top of Hinge ~ 28"



Fixed Dock Kit

YAKF2001

When connecting to a fixed dock use the Pole Connectors to glide on 2" sch 40 pipe (not included) as water levels change.

Kit Includes:

(2) Pole Bracket Sleeves

(2) 1000 Series - Low Profile Pole Connector

*Need 2 - 2" I.D. Pipe



Float Connectors

YAK1000 - 1000 Series Connectors

YAK2000 - 2000 Series Connectors

Three 1000 Series Float Connectors for 1000 Series Dock.

Two 2000 Series Float Connectors for 2000 Series Dock.

Personal Watercraft Docking



Connect-A-Port floating PWC docks provide a safe and easy docking system for your jet ski. Our high-end rollers allow you to glide easily on and off the port and provide a hassle-free experience for riders.

This Jet Ski Port is equipped with smooth rollers for effortless docking and launching and a safety-enhanced design for peace of mind. Whether you're using a hinge bracket kit for floating docks or a 2" pole and connector kit for fixed docks, installation is a breeze.



XL5

59" x 156" x 23" (149.9 cm x 396.24 cm x 58.42 cm)
Weight: 320 lbs (145.15 kg)
Maximum Flotation: 1800 lbs (816.5 kg)
Model: CAPXL5



XL6

72" x 156" x 23" (182.88 cm x 396.24 cm x 58.42 cm)
Weight: 375 lbs (170.1 kg)
Maximum Flotation: 2000 lbs (907.2 kg)
Model: CAPXL6

Benefits

- Up to Three-Place Pwcs
- Ultra Tough Construction
- Multiple Roller Positions
- Cable & Clip For Securing Pwc
- Anti-Skid Walk Area
- Universal Hull Support
- Front or Side Mounting
- Bow Stop (Removable)

Options

- Connecting Hardware To Link Multiple Units Side By Side
- Attachment Kit for Fixed Docks & Other Floating Docks
- Mooring to Connect-A-Dock 2000 Series (Front Or Side)
- Bow Stop Winch
- Five Color Options

Anchoring - XL6 & XL5



Floating Dock
AKH1212
Available in all colors.



Fixed Dock Attachment Kit
PC1212
Available in all colors.
•Poles not included



2000 Series Attachment Kit
AKS1212
The 2000 Series Attachment Kit is used to attach to the Connect-A-Dock 2000 Series dock for front or side mounting.

Other Anchoring Options



PWC Pole Bracket Sleeve
AKFPSM



Accessories



Winch - Crank
AKW2001
New design in development, actual product may vary
connectadock.com



Side By Side - XL6 & XL5
AKC1212

Modular Floating Dock System



Swimming, Boating & Fishing

A lifetime of waterfront adventures awaits your family with the Connect-A-Dock floating dock system. Easy to install and virtually maintenance-free, the modular sections can be configured to build docks for boating, rowing, fishing, swimming, and anything else you can imagine. The sections can be reconfigured into other options season after season, so there's no limit to the possibilities. Modular docks are perfect for homes, parks, and resorts.

Connect-A-Dock floating dock system will help you create family memories of safe and enjoyable fun around the water! These modular docks are stable, completely versatile, and extremely durable.

Color:
Light Gray
Dimensions:
90" x 120" x 10"
(225.6 cm x 304.8 cm x 25.4 cm)
Weight:
400 lbs (181.4 kg)
Maximum Flotation:
2800 lbs (1270kg)
Model:
FS1120



Connect-A-Dock is engineered with a skid-resistant surface that repels both water and the sun's extreme heat. The molded polyethylene construction ensures everyone will enjoy a splinter-free and nail-free time on the dock.



However You Connect It — Make It Your Own

- Modular design
- 8" (20.32 cm) freeboard
- Easy to install
- Wood grain anti-skid surface
- UV protected
- Environmentally friendly
- Salt water safe

1000 Series is the logical choice for extending your waterfront enjoyment providing the ultimate versatility in configuration, simple installation and extreme durability. Designed for maintenance-free use as a floating boat dock and platform, the 1000 - Low Profile is best suited for smaller bodies of water or coves that are protected from large waves. Perfect for swimming, kayaking and fishing.

The **modular connection system** allows you to configure, re-arrange and expand your dock in an unlimited variety of shapes and sizes. Go to page 16-17 to see examples of popular configurations.



1000 Series - Components



90" x 120" Float Section

90" x 120" x 10"
(228.6 cm x 304.8 cm x 25.4 cm)

FS1120

The primary component of the slip fit connection system.

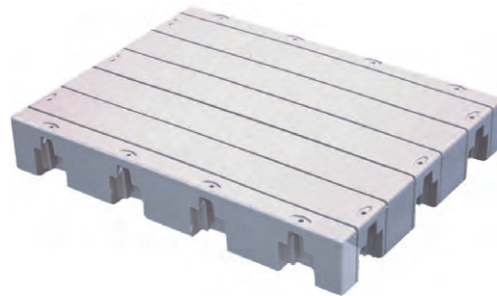

45" x 60" Float Section

45" x 60" x 10"
(114.3 cm x 152.4 cm x 25.4 cm)

FS1060

The primary component of the slip fit connection system.



45" x 30" Float Section

45" x 30" x 10"
(114.3 cm x 76.2 cm x 25.4 cm)

FS1030

A smaller float section that is half as big as the FS1060, when a little more length is needed.



Corner Float Section

44" x 33" x 10"
(111.8 cm x 83.8 cm x 25.4 cm)

CFS1010

Adds strength, stability and extra walking space to the fingers of your dock.



Float Connector

7" x 6" x 9"
(17.78 cm x 15.24 cm x 22.86 cm)

FC1010

Slip fits into the Float Section sockets to hold the sections together.



Float Connector (Blow Molded)

5.5" x 5.1" x 6.68"
(13.97 cm x 12.95 cm x 16.97 cm)

FC1020BM

Slip fits into the Float Section sockets to hold the sections together.



2" Pole Connector

10" x 6" x 10"
(25.4 cm x 15.24 cm x 25.4 cm)

PC1010

Slips into the outer sockets of the dock and used for anchoring.



2" Pole Cover

41"
(104.14 cm)

PC1002

Improves appearance of anchoring poles.



Extra Flotation

29.5" x 14" x 9.5"
(74.9 cm x 35.5 cm x 24.1 cm)

EF1010

Slips under dock to provide extra flotation where needed.



Accessory Connector

3.5" x 6" x 9"
(8.89 cm x 15.24 cm x 22.86 cm)

AC1000

Accessories can be attached to this handy connector.



Finishing Connector

2.5" x 6.2" x 9.3"
(6.35 cm x 15.75 cm x 23.6 cm)

FC1000

Fill the outer connector sockets of your dock for a finished look.



Cleat

7" x 1.35"
(17.78 cm x 3.43 cm)

8C1020

Keeps your watercraft tied near the dock.



Solar Cleat

8" x 2.125"
(20.32 cm x 5.397 cm)

LL-SCL-CAD

Secure your boat & light up the dock edge.



Commerical Kayak Launch

Connect-A-Dock launch system provides a safe and convenient way to access your kayak or canoe. Simple to launch and retrieve using Stoltz rollers and entry assist rails. Attaching to the 1000 Series low profile dock system provides a floating platform that adjusts to changing water levels.



- Convenient to use for people of all skill levels
- Slip resistant surface
- Accessible from all sides
- Expandable to accommodate all size kayaks and canoes
- Superior stability
- Dry launch and retrieval





Kayak Rack

6' x 18.25"
(182.9 cm x 46.36 cm)

KR1020

Store two kayaks on your dock.



Stationary Swim Ladder

27" x 59.25"
(68.6 cm x 150.5 cm)

SL1020

Metal Accessory Connectors are required to attach to a 1000 Series dock.



1000 Series - Components



1000 Series Metal Accessory Connector

4.5" x 5.5" x 10"
(11.4 cm x 14 cm x 25.4 cm)
4-5021

Add accessories to dock sections or connect to other docks.

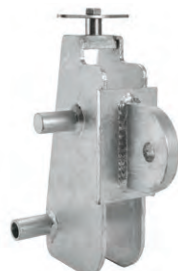

1000 Series Connector Male Hinge

6.5" x 5.5" x 10"
(16.5 cm x 14 cm x 25.4 cm)
4-5022

Attach 1000 Series float sections to other docks at different heights.



Female Hinge

5" x 3" x 12.75"
(12.7 cm x 7.6 cm x 32.4 cm)
4-5024

Attach 1000 Series float sections to other docks.



5 x 5 Hinge

5" x 5" x 3.5"
(12.7 cm x 12.7 cm x 8.9 cm)
5x5 Hinge Male - 4-5025
5x5 Hinge Female - 4-5023

Pin/Clip - 401-5026
Attach 1000 Series float sections to other docks.

*Parts sold together or separately



Self-Wicking Planter

10" diameter x 11.625"
(25.4 cm diameter x 29.5 cm)
SWP1020

Enjoy your favorite flowers and plants.



Edge Bumper

2.5" x 3.5" x 8'
(6.35 cm x 8.89 cm x 243.84 cm)
EB1020

Wheelchair edge bumper.



26" Guardrail
26" x 40"
(66.04 cm x 101.6 cm)
GR1026
(2 AC1000 Accessory Connectors and Hardware included)



Gangway Hinge 44" (Shown)
44" x 4"
(118.8 cm x 10.16 cm)
GH2010 - Stainless steel
* Also available in Galvanized



3' x 8' Aluminum Gangway with Handrails
3' x 8' x 3'
(91.4 cm x 243.8 cm x 91.4 cm)
GWA3X8



41" Guardrail
41" x 40"
(104.14 cm x 101.6 cm)
GR1041
(2 AC1000 Accessory Connectors and Hardware included)

Gangway Hinge 54"
54" x 8"
(137.16 cm x 20.32 cm)
GHGW5
* Used only with GW1024, GW1028, or GW1032

3' x 12' Aluminum Gangway with Handrails
3' x 12' x 3'
(91.4 cm x 365.8 cm x 91.4 cm)
GWA3X12



56" Guardrail
56" x 40"
(142.24 cm x 101.6 cm)
GR1056
(2 AC1000 Accessory Connectors and Hardware included) Strong aluminum guardrails offer safety

Gangway Hinge 56"
56" x 6.94"
(142.24 cm x 17.63 cm)
GH2156 - Stainless steel
* Also available in Galvanized

3' x 16' Aluminum Gangway with Handrails
3' x 16' x 3'
(91.4 cm x 487.7 cm x 91.4 cm)
GWA3X16

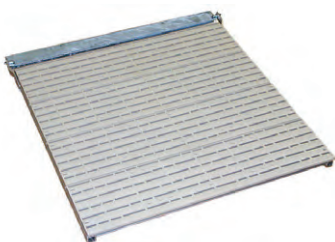

Gangway 4' x 4' (shown)
49.96" x 53.7"
(126.9 cm x 136.4 cm)
GW1024

4' x 8' Aluminum Gangway with Handrails (Shown)
4' x 8' x 3'
(121.9 cm x 243.8 cm x 91.4 cm)
GWA4X8

Gangway 4' x 8'
49.96" x 98.8"
(126.9 cm x 250.95 cm)
GW1028

4' x 12' Aluminum Gangway with Handrails
4' x 12' x 3'
(121.9 cm x 365.8 cm x 91.4 cm)
GWA4X12

Gangway 4' x 12'
49.96" x 144"
(126.9 cm x 365.76 cm)
GW1032
Light weight frame with slip resistant panels.

4' x 16' Aluminum Gangway with Handrails
4' x 16' x 3'
(121.9 cm x 487.7 cm x 91.4 cm)
GWA4X16

1000 Series - Components



Solar Light
3.36" x 1.68 x 7.73"
(8.54 cm x 4.27 cm x 19.6 cm)
SLD1020
Light up the dock edge at night.
Sold in pairs



Solar Pole Light
LL-SKL-L10-S30
When motion is detected the super bright LEDs light your dock. 12-watt solar panel with a 5-watt LED
* Pole not included



Piling Pole Cap
In Black or White
Sizes: 2", 3", 4", 6", 8",
10" or 12"



Rectangle Dock Box

48.25" x 26.5" x 29"
(122.6 cm x 67.31 cm x 73.7 cm)
DBT8006
Extra heavy duty construction
in our Dock Box with lockable,
reinforced cover.



Dock Box Corner

48.25" x 28" x 30"
(122.6 cm x 71.12 cm x 76.2 cm)
DBT8000
Cover restrained with stainless
steel cables.



Small Rectangle Dock Box

36" x 26" x 20"
(91.44 cm x 66.04 cm x 50.8 cm)
DBT8002
Long term ultraviolet inhibitors
protect against sun rays



PowerHouse - Dock Box Corner

50" x 29.5" x 32.5"
(127 cm x 74.93 cm x 82.55 cm)
DBT8004
Plenty of storage space



Large Corner Dock Box

59.25" x 34.5" x 28.5"
(150.34 cm x 87.63 cm x 72.39 cm)
DBT8011
Lockable, reinforced cover & easy to
assemble nylon hinges with stainless
steel hardware.

1000 Series - Dock Packages (F, L, Swim Platform)

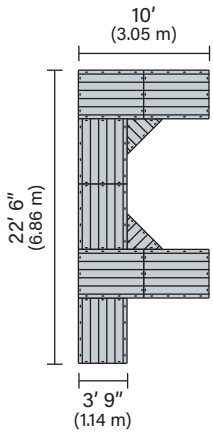

fpk1012

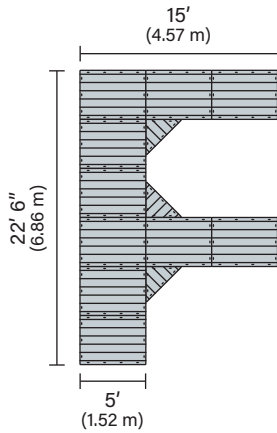

fpk1013

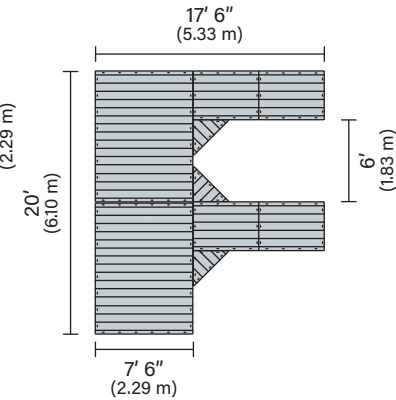

fpk1014

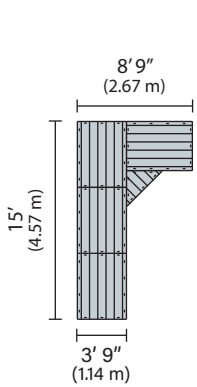

lpk1011

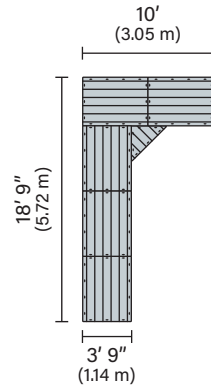

lpk1012

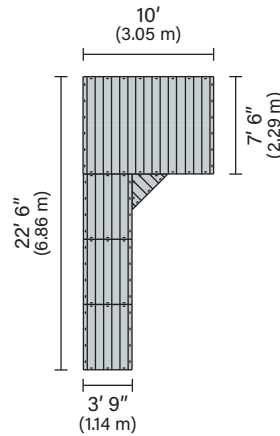

lpk1014

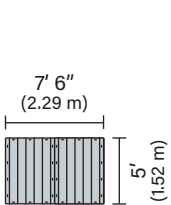

ppk1009

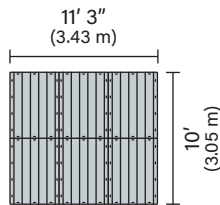

ppk1011

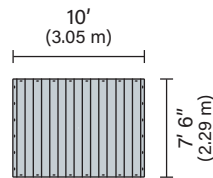

ppk1012



Mix, rearrange or change — Add Cleats, Gangway, Swim Ladder & More

1000 Series - Dock Packages (F, L, Swim Platform)

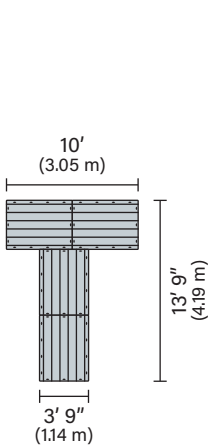

tpk1012

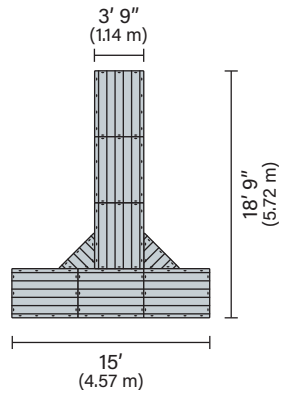

tpk1013

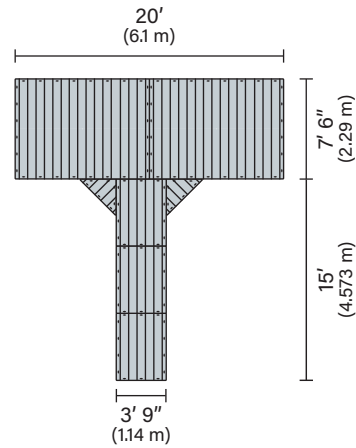

tpk1015

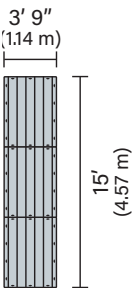

spk1013

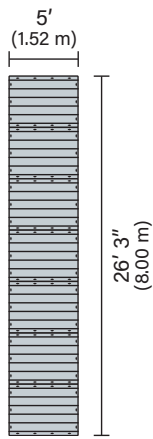

spk1015

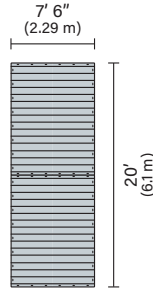

spk1016

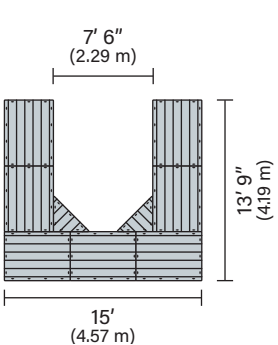

upk1011

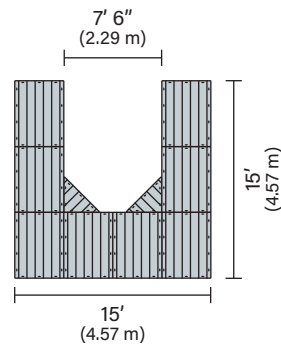

upk1012

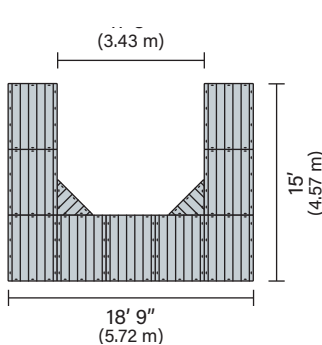

upk1013



Visit our website to see a list of individual package components

Modular Floating Dock System



Home & Commercial Docks

A season's worth of adventures awaits with your floating dock, including parties, sunbathing, swimming, fishing, and boating. A Connect-A-Dock system will prove to be a worthwhile addition to the value of your property. The 2000 Series high profile dock is also ideal for commercial applications like marinas and parks because of its increased modularity.

These docks can be expanded to any width or length, making it easy to accommodate additional docking slips or reconfiguring for various boat sizes. Stable, completely versatile and extremely durable, the Connect-A-Dock system is easy to install and virtually maintenance free. The modular float sections can be assembled into a variety of attractive configurations, then rearranged season after season. Go to page 30-31 to see examples of popular configurations.

Color:
Light Gray
Dimensions:
72" x 120" x 20"
(182.9 cm x 304.8 cm x 51 cm)
Weight:
420 lbs (190.51 kg)
Maximum Flotation:
4800 lbs (2177 kg)
Model:
FS2120



Connect-A-Dock is engineered with a skid-resistant surface that repels both water and the sun's extreme heat. The molded polyethylene construction ensures everyone will enjoy a splinter-free and nail-free time on the dock.



However You Connect It — Make It Your Own

- Modular design
- 17" (43.18 cm) freeboard
- Easy to install
- Wood grain anti-skid surface
- UV protected
- Environmentally friendly
- Salt water safe

2000 Series creates a substantial and attractive presence on the waterfront. Its modular design and rugged construction make Connect-A-Dock the simplest, most reliable way to build floating decks and boat docks for larger boats at home, in resorts and at marinas. Use it to provide safe and enjoyable access to the water for your family, and the community!

Connect-A-Port PWC Drive On adds a safe harbor for your one, two, or three seat personal watercraft! Docking is easy with the unique bow stop. Launching is a breeze — just roll off and you are ready to go! Attaches easily to the 2000 series dock or to other floating and fixed dock setups.



2000 Series - Components



72" x 120" Float Section

72" x 120" x 20"
(182.9 cm x 304.8 cm x 51 cm)
FS2120

The primary component of the easy slip fit connection system.

48" x 96" Float Section

48" x 96" x 20"
(122 cm x 244 cm x 51 cm)
FS2096

The primary component of the easy slip fit connection system.



Corner Float Section

48" x 67" x 20"
(121.9 cm x 170.1 cm x 50.8 cm)
CFS2022

Adds strength, stability and extra walking space to the fingers of your dock.



2' x 4' Float Section

24" x 48" x 20"
(60.96 cm x 122 cm x 50.8 cm)
FS2024

Adds two feet to any section on your Connect-A-Dock.



Pole Connector

14" x 9" x 20"
(35.56 cm x 22.86 cm x 50.8 cm)
2" - PC2022
3" - PC2023

Slips into the outer sockets of the dock and used for anchoring.



Dual Pole Connector

12.52" x 20" x 40"
(31.8 cm x 50.8 cm x 101.6 cm)
DPC2023

Two connection points for added strength.



Float Connector

12" x 9" x 20"
(30.48 cm x 22.86 cm x 50.8 cm)
FC2020

Slip fits into the Float Section sockets to hold the sections together.

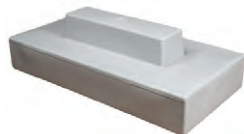

Extra Flotation

48" x 24" x 14"
(122 cm x 60.96 cm x 35.5 cm)
EF2020

Slips under your dock to provide extra lift where needed.



2" Pole Cover

41"
(104.14 cm)
PC1002

Improves appearance of anchoring poles.



2000 Bumper

10.6" x 10.6" x 20"
(26.9 cm x 26.9 cm x 51 cm)
DB2000

2000 Bumper attaches in the float section sockets.



Connect-A-Port XL6

72" x 156" x 23"
 (182.88 cm x 396.24 cm x 58.42 cm)
 CAPXL6

Connect-A-Port XL5

59" x 156" x 23"
 (149.9 cm x 396.24 cm x 58.42 cm)
 CAPXL5

PWC Drive On adds a safe harbor for your one-, two- or three-seat personal watercraft. Connect to the 2000 Series dock, floating docks or fixed docks.

Connection kits XL6 & XL5

2000 Series Attachment Kit
 AKS2000
 PWC Side by Side Kit
 AKC2002



Accessory Connector

5.75" x 19.125" x 8.625"
 (14.60 cm x 48.57 cm x 21.91 cm)
 AC2000

Accessories can be attached to this handy connector.

Finishing Connector

3" x 19" x 9"
 (7.62 cm x 48.26 cm x 22.86 cm)
 FC2000

Fill the outer connector sockets of your dock for a finished look.



2000 Series - Components



Gangway 4' x 4'
49.96" x 53.7"
(126.9 cm x 136.4 cm)
GW1024

Gangway 6' x 8'
72.5" x 96"
(184.15 cm x 243.84 cm)
GW1036

Gangway Hinge 44" (Shown)
44" x 4"
(118.8 cm x 10.16 cm)
GH2010 - Stainless Steel
* Also available in Galvanized

Gangway 4' x 8' (shown)
49.96" x 98.8"
(126.9 cm x 250.95 cm)
GW1028

Gangway Hinge 54"
54" x 8"
(137.16 cm x 20.32 cm)
GHGW5

Gangway 4' x 12'
49.96" x 144"
(126.9 cm x 365.76 cm)
GW1032
Lightweight frame with slip resistant panels.

* Used only with GW1024, GW1028, or GW1032

Gangway Hinge 56"
56" x 6.94"
(142.24 cm x 17.63 cm)
GH2156 - Stainless Steel
* Also available in Galvanized





**3' x 8' Aluminum Gangway
with Handrails**

3' x 8' x 3'
(91.4 cm x 243.8 cm x 91.4 cm)
GWA3X8

**4' x 8' Aluminum Gangway
with Handrails (Shown)**

4' x 8' x 3'
(121.9 cm x 243.8 cm x 91.4 cm)
GWA4X8

**3' x 12' Aluminum Gangway
with Handrails**

3' x 12' x 3'
(91.4 cm x 365.8 cm x 91.4 cm)
GWA3X12

**4' x 12' Aluminum Gangway
with Handrails**

4' x 12' x 3'
(121.9 cm x 365.8 cm x 91.4 cm)
GWA4X12

**3' x 16' Aluminum Gangway
with Handrails**

3' x 16' x 3'
(91.4 cm x 487.7 cm x 91.4 cm)
GWA3X16

**4' x 16' Aluminum Gangway
with Handrails**

4' x 16' x 3'
(121.9 cm x 487.7 cm x 91.4 cm)
GWA4X16



Note: Additional aluminum gangways are available on special order from the manufacturer.

2000 Series - Components



Utility Channel - Straight

49.56" x 24" x 20"
(125.88 cm x 60.96 cm x 50.8 cm)
UT2048

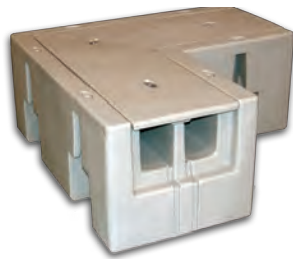

Utility Channel - Corner

47.91" x 47.91" x 20"
(121.7 cm x 121.7 cm x 50.8 cm)
UTC2048



Utility Channel - Cube

23.81" x 24" x 20"
(60.47 cm x 60.96 cm x 50.8 cm)
UT2024



Harbor Light

42.5" x 11.125" x 11.125"
107.95 cm x 28.26 cm x 28.26 cm
HL301000
Add water, electrical lines

Run water, electrical or sewer
conduit lines.



Marina Mate SS

30" x 7" x 7"
76.2 cm x 17.78 cm x 17.78 cm
MMSS2050
Add water, electrical lines



Fire Station

42.5" x 11.125" x 11.125"
107.95 cm x 28.26 cm x 28.26 cm)
FS1020
Created as a complete solution for
fire and rescue needs



Bayside Utility Center

14.5" x 11" x 10.625"
36.83cm x 27.94cm x 61.29cm
BU3050
Host to a variety of electrical
services, contained in a compact
yet strong housing



Flag Pole

FP2000

Pole Bracket

PB2020

Accessory Connector-Metal

AC2022MTL

Telescoping Flag Pole - 10', 15' or 20'



Solar Cleat

8" x 2.125"
(20.32 cm x 5.397 cm)

LL-SCL-CAD

Secure your boat & light up the dock edge.



Self-Wicking Planter

10" diameter x 11.625"
(25.4 cm diameter x 29.5 cm)

SWP1020

Enjoy your favorite flowers and plants while you relax on your dock.



Cleat

7" x 1.35"
(17.78 cm x 3.43 cm)

8C1020

A strong, secure tie off for your mooring lines.

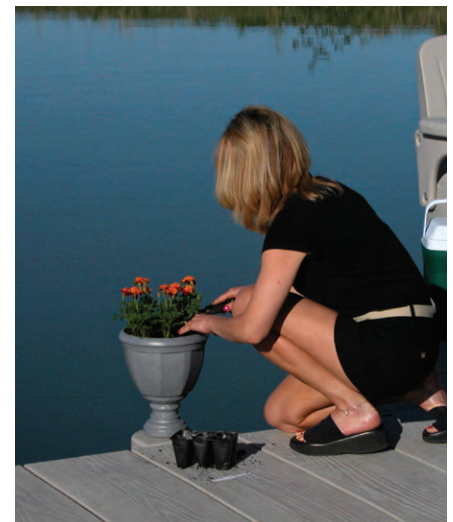

Stationary Swim Ladder

27" x 59.25"
(68.6 cm x 150.5 cm)

SL1020

Metal Accessory Connectors are required to attach to a 2000 Series dock.



Dual Cleat

11" x 2.25"
(27.94 cm x 5.72 cm)

DC2000

Connect the stainless steel cleat at two connector points.

2000 Series - Components

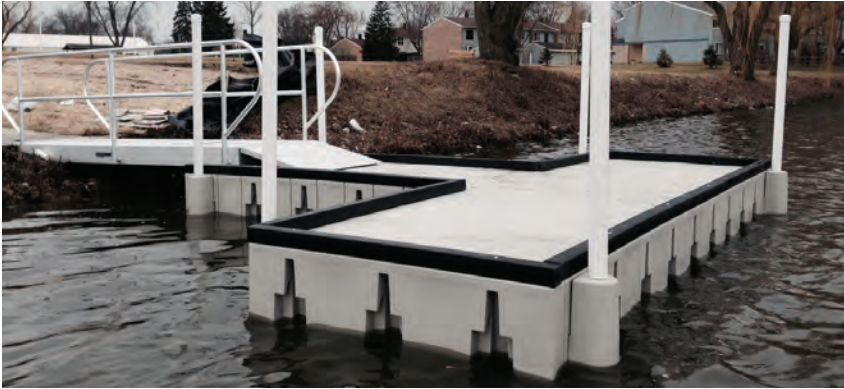

2000 Series Bench

48" x 22" x 38.5"
(121.92 cm x 55.88 cm x 97.79 cm)
BH2000

Take time to sit back and enjoy life on your bench!



Kayak Rack

6' x 18.25"
(182.9 cm x 46.36 cm)
KR1020

Store two Kayaks on your dock.



Edge Bumper

2.5" x 3.5" x 8'
(6.35 cm x 8.89 cm x 243.84 cm)
EB1020

Wheelchair edge bumper.



Piling Pole Cap

In Black or White
Sizes: 2", 3", 4", 6", 8", 10" or 12"



Female Hinge

5" x 3" x 12.75"
(12.7 cm x 7.6 cm x 32.4 cm)
4-5024

Attach 2000 Series float sections to other docks.



2000 Series Metal Accessory Connector

7" x 8.125" x 17.125"
(17.78 cm x 20.64 cm x 43.18 cm)
4-5679

Add accessories to dock sections or connect to other docks.



5 x 5 Hinge

5" x 5" x 3.5"
(12.7 cm x 12.7 cm x 8.9 cm)
5x5 Hinge Male - 4-5025

5x5 Hinge Female - 4-5023

Pin/Clip - 401-5026

Attach 2000 Series float sections to other docks.

*Parts sold together or separately



Rectangle Dock Box

48.25" x 26.5" x 29"
(122.6 cm x 67.31 cm x 73.7 cm)
DBT8006
Extra heavy duty construction
in our Dock Box with lockable,
reinforced cover.



Dock Box Corner

48.25" x 28" x 30"
(122.6 cm x 71.12 cm x 76.2 cm)
DBT8000
Cover restrained with stainless
steel cables.



Small Rectangle Dock Box

36" x 26" x 20"
(91.44 cm x 66.04 cm x 50.8 cm)
DBT8002
Long term ultraviolet inhibitors
protect against sun rays.



PowerHouse - Dock Box Corner

50" x 29.5" x 32.5"
(127 cm x 74.93 cm x 82.55 cm)
DBT8004
Plenty of storage space.



Large Corner Dock Box

59.25" x 34.5" x 28.5"
(150.34 cm x 87.63 cm x 72.39 cm)
DBT8011
Lockable, reinforced cover & easy to
assemble nylon hinges with stainless
steel hardware.

2000 Series - Components

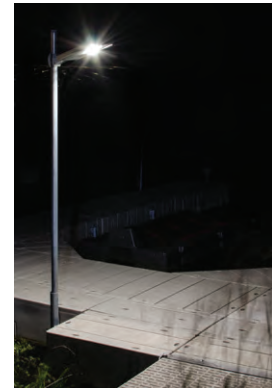
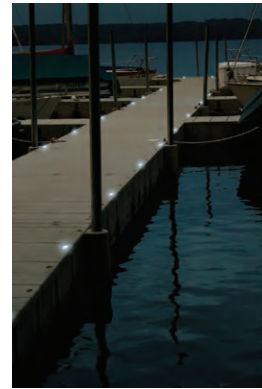

44" Guardrail

44" x 40"
(111.76 cm x 101.6 cm)

GR2044

Color: brown or white
(2 AC2000 Accessory Connectors and Hardware included)



Solar Light

3.36" x 1.68 x 7.73"
(8.54 cm x 4.27 cm x 19.6 cm)

SLD1020

Light up the dock edge at night.

Sold in pairs



Solar Pole Light

LL-SKL-L10-S30

When motion is detected the super bright LEDs light your dock. 12-watt solar panel with a 5-watt LED
* Pole not included



67" Guardrail

67" x 40"
(170.18 cm x 101.6 cm)

GR2067

Color: brown or white
(2 AC2000 Accessory Connectors and Hardware included)



2" Bracket Receiver Bolt On

40-5922

Will accept 2" od square tubing.



2000 Series Clamp Connector

40-5923

Increase clamping force on the connector socket.

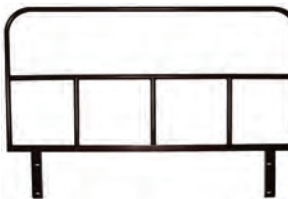

92" Guardrail

92" x 40"
(233.68 cm x 101.6 cm)

GR2092

Color: brown or white
(2 AC2000 Accessory Connectors and Hardware included)
Strong powder coated, steel guardrails.



Dock Roof

Protect your boat and other watercraft investments from harmful UV Rays. Construct a roof system for your new or existing dock. Contact your local dealer or the manufacturer for more information.

- Galvanized steel frame
 - Available for home or commercial use
- Roof Photo - Display only - Roof not sold by Connect-A-Dock.



Use our Design a Dock tool to explore your dream layout

CONNECT-A-DOCK
DESIGN A DOCK

2000 SERIES - HIGH PROFILE
NEED HELP? / INSTRUCTIONS

DOCK SECTIONS	GANGWAYS / RAILS	DOCK ACCESSORIES	ADDITIONAL PARTS
 FLOAT SECTION 24 X 48	 FLOAT SECTION 48 X 96	 FLOAT SECTION 72 X 120	 CORNER FLOAT SECTION 48 X 67
 UTILITY CORNER 44 X 48	 UTILITY CORNER 24 X 48		

[NEED ADDITIONAL INFORMATION](#)

APPROXIMATE CONNECTORS REQUIRED: 15

[VIEW PARTS LIST](#) [PRINT](#)

EMAIL PARTS LIST

Email:

Alt Email:

Name:

Phone:

Email notes:

*email will be sent to all above along with a CAD sales rep



Scan the QR code to design your own 1000 Series or 2000 Series dock layout.

2000 Series - Dock Packages (F, L, Deck)

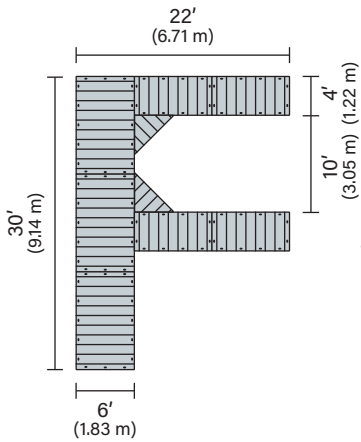

fpk2013

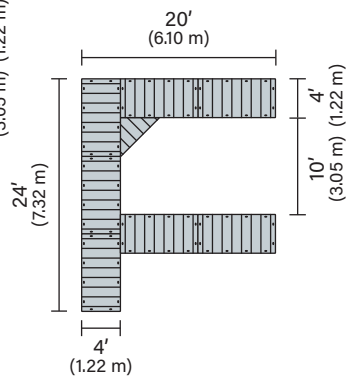

fpk2014

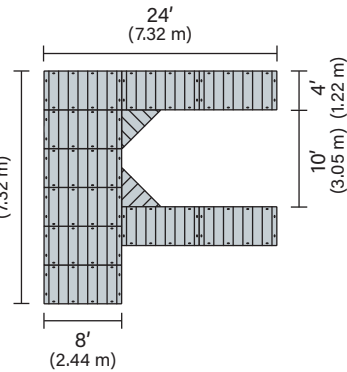

fpk2015

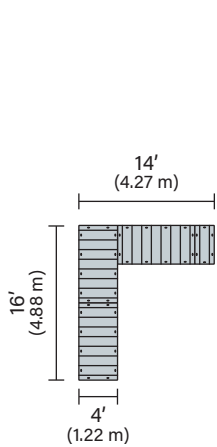

lpk2013

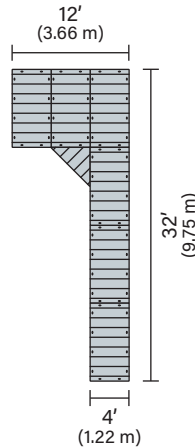

lpk2014

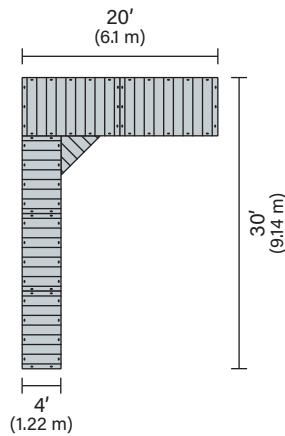

lpk2015

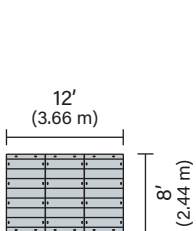

dpk2008

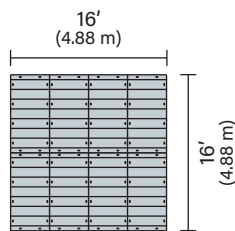

dpk2009

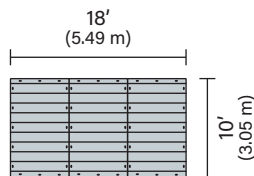

dpk2010



Mix, rearrange or change — Add a Gangway, Bench, PWC Drive On & More

2000 Series - Dock Packages (T, Straight, U)

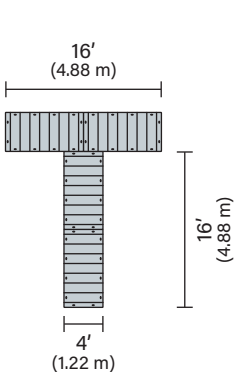

tpk2012

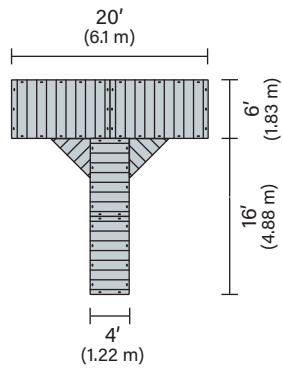

tpk2013

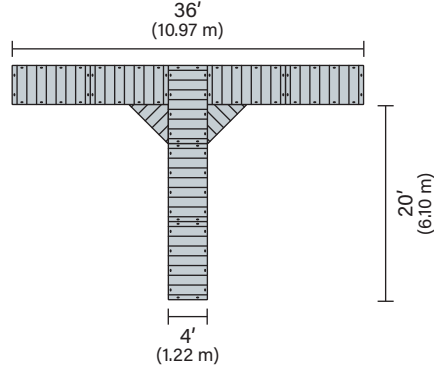

tpk2014

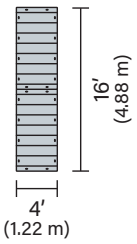

spk2010

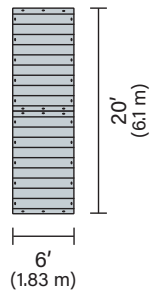

spk2011

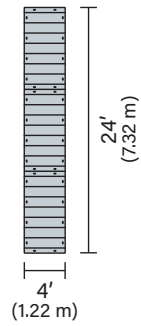

spk2012

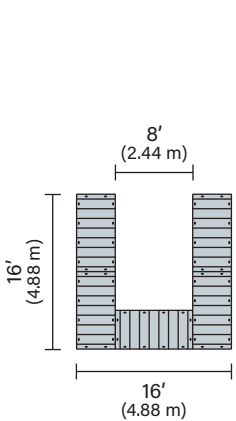

upk2015

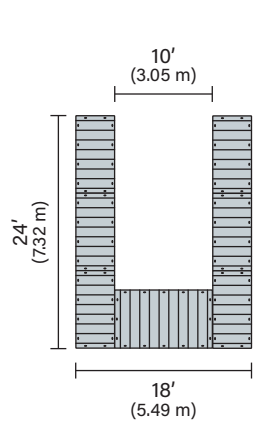

upk2016

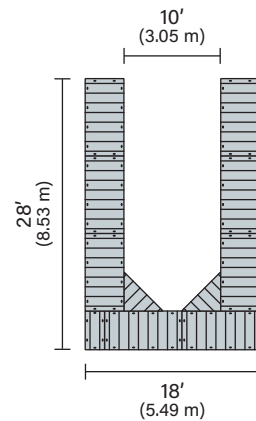

upk2017



Visit our website to see a list of individual package components

Stiff Arm



Note: Dock anchoring methods listed in this book are only suggestions. It is up to you to determine which method suits your needs.

Unless stated, anchoring items can be used for both 1000 SERIES (LP) & 2000 SERIES (HP) dock systems.



Stiff Arm Fittings

2" (5.08 cm) Id pole
SAF1020
Connects a pole to the permanent land fitting and the Stiff Arm Bracket.



Stiff Arm Bracket

SAB1020
Attaches to the side of the dock and provides slot for Stiff Arm Fitting.



Pole Pounder

2" & 3" pipe
(5.08 cm & 7.62 cm)
PP1002
Makes driving poles easy.



Pole Remover

2" & 3" pipe
(5.08 cm & 7.62 cm)
PR1002
Makes pulling poles easy.



2" Pole Auger

2" id pole (5.08 cm)
PA1002
Attaches to poles for easy anchoring.

Gangway



Roller Kit

2" x 10.5" x 3"
 (5.08 cm x 26.67 cm x 7.62 cm)
 RK1020 - (sold in pairs)
 Allows gangway to roll on the dock in fluctuating waters.

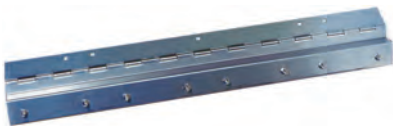

Gangway Hinge 44"

44" x 4" x 1/8"
 (111.8 cm x 10.16 cm x 0.32 cm)
 GH2010 - Stainless Steel
 Enables connection from gangway to dock and allows the gangway to fold 180° (wood plank not included).
 * Also available in Galvanized

Gangway Hinge 54"

54" x 8"
 (137.16 cm x 20.32 cm)
 GHGW5
 * Used only with GW1024, GW1028, or GW1032

Gangway Hinge 56"

56" x 6.94"
 (142.24 cm x 17.63 cm)
 GH2156 - Stainless Steel
 * Also available in galvanized

Piling Loop



10" (25.4 cm) Piling Loop

PL1010
 Lets your dock ride on the pilings of a pier or other piling structures. Perfect for fluctuating waters.

Other piling loop sizes:

- 12" (30.48 cm)**
PL1012
- 14" (35.56 cm)**
PL1014
- 16" (40.64 cm)**
PL1016
- 18" (45.72 cm)**
PL1018

Chain



Deep Water Hardware 1000 Series

DW1010
 Anchors a dock or Swim Platform in deep water.



2" Dead Man Collar 1000 Series

DM1002
2000 Series
 DM2002
 Use with Pole Connector to anchor any dock in deep water with chain and weight.

Technical Specifications

1000 Series - Low Profile

	Model	Size	Weight	Deck Surface Square Footage	Maximum Flotation
45" x 30" Float Section	FS1030	30" x 45" x 10" (76.2 cm x 114.3 cm x 25.4 cm)	50 lbs (22.68 kg)	9.375 ft ² (0.871 m ²)	325 lbs (147 kg) per section
45" x 60" Float Section	FS1060	60" x 45" x 10" (152.4 cm x 114.3 cm x 25.4 cm)	110 lbs (49.9 kg)	18.75 ft ² (1.74 m ²)	690 lbs (313 kg) per section
90" x 120" Float Section	FS1120	90" x 120" x 10" (228.6 cm x 304.8 cm x 25.4 cm)	400 lbs (181.4 kg)	75 ft ² (22.86 m ²)	2800 lbs (1270 kg) per section
44" x 33" Corner Float Section	CFS1010	44" x 33" x 10" (111.8 cm x 83.8 cm x 25.4 cm)	30 lbs (13.6 kg)	5.05 ft ² (0.469 m ²)	150 lbs (68 kg) per section
Extra Flotation	EF1010	29.5" x 14" x 9.5" (74.9 cm x 35.5 cm x 24.1 cm)	9 lbs (4.08 kg)	–	60 lbs (27.21 kg) per section
		Can be stacked into each other for added buoyancy			
Extra Hardware	EH1000	–	–	–	–
		6 per pack			
2" Pole Connector	PC1010	10" x 6" x 10" (25.4 cm x 15.24 cm x 25.4 cm)	4 lbs (1.81 kg)	–	–
		max 2.375" (6.03 cm) pole			
Accessory Connector	AC1000	3.5" x 6" x 9" (8.89 cm x 15.24 cm x 22.86 cm)	1.7 lbs (0.77 kg)	–	–
		5" (12.7 cm) distance on center for t-nuts 3/8"-16 UNC x 5/8" (10 mm)			

Freeboard Live Load Anchoring Connectors Sockets

8" (20.32 cm)
35 lbs/foot² (170 kilogram/meter²)
Max~15" (38.1 cm) apart

Material Average Wall Thickness

Linear Low Density Polyethylene Plastic
1/4" (0.635 cm)

2000 Series - High Profile (HP)

	Model	Size	Weight	Deck Surface Square Footage	Maximum Flotation
72" x 120" Float Section	FS2120	72" x 120" x 20" (182.9 cm x 304.8 cm x 51 cm)	420 lbs (190.5 kg)	60 ft ² (5.57 m ²)	4800 lbs (2177 kg) per section
48" x 96" Float Section	FS2096	48" x 96" x 20" (122 cm x 244 cm x 51 cm)	230 lbs (104.3 kg)	32 ft ² (2.97 m ²)	2500 lbs (1134 kg) per section
2' x 4' Float Section	FS2024	48" x 24" x 20" (122 cm x 60.96 cm x 51 cm)	60 lbs (27.22 kg)	8 ft ² (0.47 m ²)	600 lbs (272 kg) per section
		Staggering with alternating 2096 sections will add strength & stability			
48" x 67" Corner Float Section	CFS2022	48" x 67" x 20" (121.9 cm x 170.1 cm x 50.8 cm)	75 lbs (34 kg)	21 ft ² (1.95 m ²)	550 lbs (249.5 kg) per section
Extra Flotation	EF2020	48" x 24" x 14" (121.9 cm x 60.96 cm x 35.5 cm)	30 lbs (13.6 kg)	–	300 lbs (136 kg) per section
		Can be stacked into each other for added buoyancy			
Extra Hardware	EH2000	–	–	–	–
		6 per pack			
2" Pole Connector	PC2022	9" x 14" x 20" (22.86 cm x 35.56 cm x 50.8 cm)	12 lbs (5.44 kg)	–	–
		max 2.375" (6.03 cm) pole			
3" Pole Connector	PC2023	9" x 14" x 20" (22.86 cm x 35.56 cm x 50.8 cm)	12 lbs (5.44 kg)	–	–
		max 3.5" (8.89 cm) pole			
Dual Pole Connector	DPC2023	14.5" x 40" x 20" (36.8 cm x 101.6 cm x 50.8 cm)	30 lbs (13.6 kg)	–	–
		max 3.5" (8.89 cm) pole			
Accessory Connector	AC2000	5.75" x 19.125" x 8.625" (14.60 cm x 48.57 cm x 21.91 cm)	4 lbs (1.81 kg)	–	–
		9.188" (23.34 cm) distance on center for t-nuts 3/8"-16 UNC X 5/8" (10 mm)			
Utility Channel - Straight	UT2048	49.56" x 24" x 20" (125.88 cm x 60.96 cm x 50.8 cm)	79.5 lbs (36 kg)	8 ft ² (0.74 m ²)	600 lbs (272 kg)
Utility Channel - Corner	UTC2048	47.91" x 47.91" x 20" (121.7 cm x 121.7 cm x 50.8 cm)	116 lbs (52.6 kg)	12 ft ² (1.1 m ²)	800 lbs (362.9 kg)
Utility Channel - Cube	UT2024	23.81" x 24" x 20" (60.47 cm x 60.96 cm x 50.8 cm)	42 lbs (19.1 kg)	4 ft ² (0.37 m ²)	800 lbs (362.9 kg)

Freeboard Live Load Anchoring Connectors Sockets

17" (43.18 cm)
75 lbs/foot² (365 kilogram/meter²)
Max~24" (60.96 cm) apart

Material Average Wall Thickness

Linear Low Density Polyethylene Plastic
1/4" (0.635 cm)

Connect-A-Port

	Model	Size	Weight	Deck Surface Square Footage	Maximum Flotation
Connect-A-Port XL6	CAPXL6	72" x 156" x 23" (182.88 cm x 396.24 cm x 58.42 cm)	375 lbs (170.1 kg)	–	2000 lbs (907.2 kg)
		Attaches to 2000 Series and fixed docks. Multiple units can be linked.			
Connect-A-Port XL5	CAPXL5	59" x 156" x 23" (149.9 cm x 396.24 cm x 58.42 cm)	325 lbs (147.4 kg)	–	1800 lbs (816.4 kg)
		Attaches to 2000 Series and fixed docks. Multiple units can be linked.			

YAKport

	Model	Size	Weight	Deck Surface Square Footage	Maximum Flotation
YAKport	KL1020	48" x 60" x 22" (122 cm x 152 cm x 56 cm)	99 lbs (44.91 kg)	–	300 lbs (136.1 kg)
		Attaches to 1000 Series, 2000 Series and fixed docks.			



Anchoring & Accessories

Anchoring & Accessories are for both 1000 Series and 2000 Series unless stated.

	Model	Material	Other
4' x 4' Gangway	GW1024	Galvanized Steel, Aluminum & Plastic	-
4' x 8' Gangway	GW1028	Galvanized Steel, Aluminum & Plastic	-
4' x 12' Gangway	GW1032	Galvanized Steel, Aluminum & Plastic	-
3' x 8' Gangway w/Handrails	GWA3X8	Aluminum	Load Rating 50 lbs per sq ft (244.1 kg per sq m)
3' x 12' Gangway w/Handrails	GWA3X12	Aluminum	Load Rating 50 lbs per sq ft (244.1 kg per sq m)
3' x 16' Gangway w/Handrails	GWA3X16	Aluminum	Load Rating 50 lbs per sq ft (244.1 kg per sq m)
4' x 8' Gangway w/Handrails	GWA4X8	Aluminum	Load Rating 50 lbs per sq ft (244.1 kg per sq m)
4' x 12' Gangway w/Handrails	GWA4X12	Aluminum	Load Rating 50 lbs per sq ft (244.1 kg per sq m)
4' x 16' Gangway w/Handrails	GWA4X16	Aluminum	Load Rating 50 lbs per sq ft (244.1 kg per sq m)
Gangway Hinge	GH2010	Stainless Steel	Used when constructing your own gangway
Roller Kit	RK1020	Galvanized Steel & Rubber Roller	Sold in pairs
Swim Ladder	SL1020	Aluminum	450 lbs (204.12 kg) load capacity
2" Pole Cover	PC1002	Linear Low Density Polyethylene Plastic	Ø 3.070 opening
Pole Pounder	PP1002	-	Can be used for 2" or 3" (5.08 cm or 7.62 cm) pipe
Pole Remover	PR1002	-	Can be used for 2" or 3" (5.08 cm or 7.62 cm) pipe
2" Pole Auger	PA1002	Aluminum	Min 2" (5.08 cm) id Pole size
2" Dead man Collar (1000 Series)	DM1002	Galvanized Steel	Used with 2" Pole Connector PC1022 and .3125" (.794 cm) max size for chain slot
2" Dead man Collar (2000 Series)	DM1002	Galvanized Steel	Used with 2" Pole Connector PC2022 and .3125" (.794 cm) max size for chain slot
Deep Water Hardware (1000 Series)	DW1010	Stainless Steel	Attaches to dock connector socket
Stiff Arm Fittings	SAF1020	Galvanized Steel	Can be used with 2" (5.08 cm) id pipe
Stiff Arm Bracket	SAB1020	Galvanized Steel	-
Piling Loop -			
10" (25.4 cm)	PL1010	Galvanized Steel & Rubber Roller	-
12" (30.48 cm)	PL1012	Galvanized Steel & Rubber Roller	-
14" (35.56 cm)	PL1014	Galvanized Steel & Rubber Roller	-
16" (40.64 cm)	PL1016	Galvanized Steel & Rubber Roller	-
18" (45.72 cm)	PL1018	Galvanized Steel & Rubber Roller	-
Guardrail -			
26" (66.04 cm) (1000 Series)	GR1026	Aluminum	(2) Accessory Connectors AC1000 & hardware included
41" (104.14 cm) (1000 Series)	GR1041	Aluminum	(2) Accessory Connectors AC1000 & hardware included
56" (142.24 cm) (1000 Series)	GR1056	Aluminum	(2) Accessory Connectors AC1000 & hardware included
44" (111.76 cm) (2000 Series)	GR2044	Steel Powder Coated	(2) Accessory Connectors AC2000 & hardware included
67" (170.18 cm) (2000 Series)	GR2067	Steel Powder Coated	(2) Accessory Connectors AC2000 & hardware included
92" (233.68 cm) (2000 Series)	GR2092	Steel Powder Coated	(2) Accessory Connectors AC2000 & hardware included
Cleat	8C1020	30% Glass Filled Nylon	Withholds avg. of 726 lbs (329.3 kg) when loaded at 2.2"-2.3" (5.6 cm-5.8 cm) from the center

ALL SPECIFICATIONS PROVIDED BY CONNECT-A-DOCK ARE BASED UPON CONNECT-A-DOCK TEST DATA AND ARE PROVIDED WITHOUT REPRESENTATION OR WARRANTY. ACTUAL SPECIFICATIONS, WEIGHTS AND DIMENSIONS MAY VARY FOR A VARIETY OF REASONS, INCLUDING, WITHOUT LIMITATION, DUE TO THE ROTATIONAL MOLDING PROCESS. SPECIFICATIONS SHOULD BE REGRADE AS NOMINAL VALUES ONLY AND NOT AS BINDING.

Note: Dock anchoring methods listed in this book are only suggestions. It is up to you to determine which method suits your needs.

Storage-Winterization: When storing the Connect-A-Dock outside, the walking surface of the dock needs to face up. If stored upside down, water can get inside the docks through vent holes that allow air expansion.

Cleaning: For low maintenance cleaning, use a stiff broom or brush and a garden hose. A pressure washer with no heat can also be used. When using soap, use an environmentally safe product.

Note: All plastic has an inherent tendency to create static electricity. If you have a concern, please contact Connect-A-Dock.

Stainless Steel: Connect-A-Dock products use marine grade stainless steel for stainless steel metal components. Stainless steel may stain, discolor or attain an adhering layer of grime under normal service, and, especially, when used in salt water conditions. Any contamination of the metal surface by dirt or other material can reduce corrosion protection. Some corrosion can also occur when stainless steel comes in contact with dissimilar metals. The removal of dirt, grime, and surface stains that occur during normal handling and exposure to the elements is essential for optimum corrosion resistance to prevent surface staining (corrosion) or pitting. Dirt, grime and surface stains that occur during normal use and exposure to the elements should be cleaned with warm water with or without a gentle detergent, soap, or ammonia. (Caution, do not use ammonia near anodized aluminum). Persistent stains can be removed with mild, non-scratching, abrasive powders such as typical household cleaners used with warm water and a bristle brush, sponge or clean cloth followed by a rinse with clean water then wiped dry. Stubborn stains can be removed by using a damp cloth and a commercial stainless steel cleaner and polish. Rubbing lightly in the direction of the polish lines on the stainless steel, then rinsing with clean water and wiping dry.

Installation: A 1000 or 2000 Series dock should not be placed in areas with constant waves in excess of 12 inches in total wave height, as measured from crest to trough. Please note that placing a dock in an unsuitable location may void any warranty provided by Connect-A-Dock Inc. or your local distributor or dealer if you have any questions regarding the suitability of your particular dock location. Please contact your local distributor and/or dealer.

Installation & Warranties & Patents



Quick and easy installation!



Assembly only takes a few hours!



You don't have to get in the water!

The Connect-A-Dock floating dock modules are easy to connect to each other using only a few bolts in just minutes. The only tool you need is a 9/16th (16 mm) socket wrench.

Time is precious — we believe you should be spending time enjoying your dock — not assembling it!

Warranty Information

Connect-A-Dock®	U.S.A. & Canada	10 Year for polyethylene plastic components 3 Year for commercial use of polyethylene plastic components 1 Year for Accessories
Connect-A-Port XL6 & Connect-A-Port XL5 YAKport	U.S.A. & Canada	8 Year for polyethylene plastic components 1 Year for Accessories 2 Year for commercial use of polyethylene plastic components
Connect-A-Dock®	International	2 Year for polyethylene plastic components 1 Year for Accessories 1 Year for commercial use of polyethylene plastic components
Connect-A-Port XL6 & Connect-A-Port XL5 YAKport	International	2 Year for polyethylene plastic components 1 Year for commercial use of polyethylene plastic components 1 Year for Accessories

Visit connectadock.com or contact customer service for full warranty details. The warranty is subject to change at any time at the discretion of the manufacturer.

Low-maintenance, color-molded polyethylene resists oil, gas, UV rays and salt water, and won't rot, peel or splinter like wood. With a slip-resistant surface that sheds both water and the sun's extreme heat, you are assured long-term performance season after season.

CONNECT-A-DOCK® Return Policy - U.S.A. & Canada - All products returned to Connect-A-Dock are subject to a restocking fee of 25% of the total product cost. The buyer is responsible for all shipping costs incurred.

Please note that many of the products listed in this literature are protected by various United States and/or International patents or have patents pending. For a comprehensive list of our patents and the products covered please visit our website at www.connectadock.com/patents.htm. Manufacturer reserves the right to make changes without prior notice.

© 2012-2024 ver.13 Connect-A-Dock® All rights reserved. Connect-A-Dock®, the Connect-A-Dock® logo, Connect-A-Port, Connect-A-Port XL5 & XL6, YAKport®, Dandy Dock, Make a connection to life®, Connect to life are trademarks of Connect-A-Dock® Other products mentioned herein are trademarks of their respective owners.



Check out even more Marine Products at
docksuppliers.com

Dock Applications

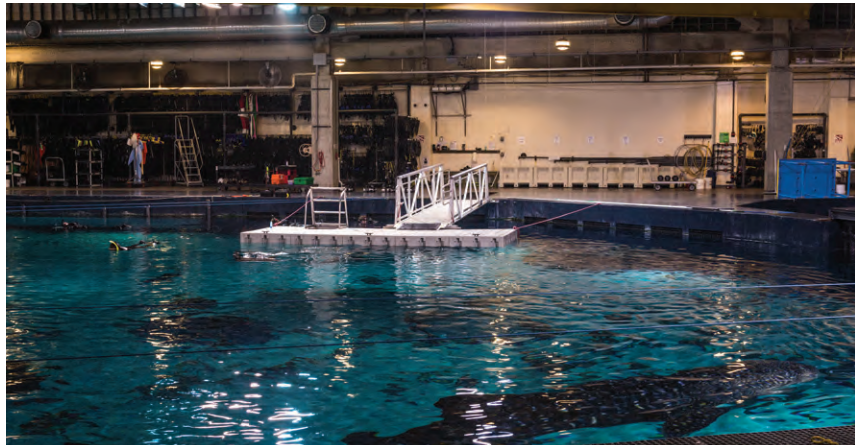
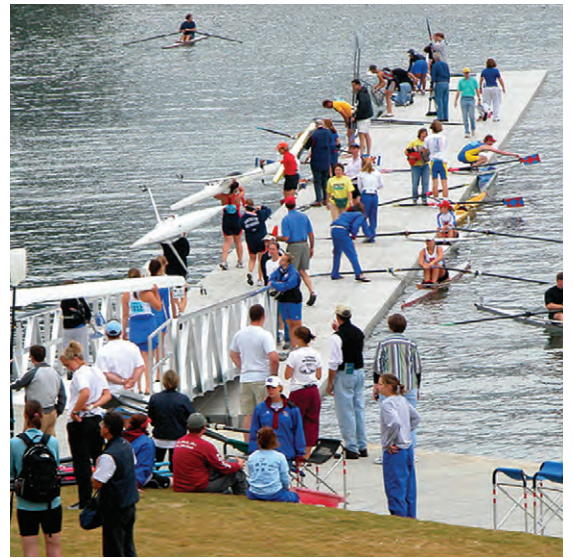



Connect-A-Dock
1501 Owner Avenue
Atlantic, IA 50022
USA



Toll Free 877-742-3071 (U.S.A. & Canada) | info@connectadock.com | connectadock.com
International +1 712-243-2430

Connect-A-Dock is a Myers Industries, Inc. brand

